



CHINA  
SEMICONDUCTOR  
CORPORATION

Spec. No.	PS-ND-0711
Rev.	A

# 納入仕様書 SAMPLE SPECIFICATION AND APPROVAL FORM PRODUCT SPECIFICATION

カスタマ

CSC CUSTOMER:

製品名

CSC PRODUCT NAME:

LED Display

型番

CSC PART NUMBER:

CSS-15102D-21

発行日

ISSUED DATE:

カスタマ承認

CUSTOMER APPROVAL:

CUSTOMER APPROVED SIGNATURES	APPROVED BY	CHECKED BY	PREPARED BY
	JackWu	Don	陳新強

CHINA SEMICONDUCTOR CORPORATION

Address:2FL. NO.909,Chung-Cheng Road,  
Chung-Ho City Taipei Hsien,Taiwan.

Tel:886-2-2223-9696

Fax:886-2-2223-9377

OPTO PLUS TECHNOLOGIES CO.,LTD

Address:696 Shun jiang Rd.,Ji Shan St.Shaoxing,  
ZheJiang,China

Tel:86-0575-8623888

Fax:86-0575-8623112



# PRODUCT SPECIFICATION

**Model No : CSS-15102D-21**

Descriptions:
<ul style="list-style-type: none"> <li>• 1.5 Inch Single Digit Display</li> <li>• Common Anode</li> <li>• Emitting Color: Super Bright Red</li> <li>• Black Face</li> <li>• White Segment</li> </ul>



CUSTOMER APPROVED	APPROVED BY	CHECKED BY	PREPARED BY
SIGNATURES	JackWu	Don	陳新強

**CHINA SEMICONDUCTOR CORPORATION**  
Address: 2FL. NO.909, Chung-Cheng Road,  
Chung-Ho City Taipei Hsien, Taiwan.

**OPTO PLUS TECHNOLOGIES CO.,LTD**  
Address: 696 Shun jiang Rd., Ji Shan St. Shaoxing,  
ZheJiang, China

Tel: 886-2-2223-9696  
Fax: 886-2-2223-9377

Tel: 86-0575-8623888  
Fax: 86-0575-8623112



Spec. No.	PS-ND-0711
Rev.	A

**Model No : CSS-15102D-21**

**■ Features -**

1. 1.5 inch (38.0mm) digit height.
2. Case mold type.
3. RoHs compliant.
4. Low power consumption.
5. ESD>1KV(HBM)
6. Easy mounting on P.C. board or socket.

**■ Device Selection Guide -**

Part No.	Chip		Face / Segment
	Material	Emitted Color	
CSS-15102D	AlGaAs	Super Bright Red	Black / White

**■ Package Dimensions -**

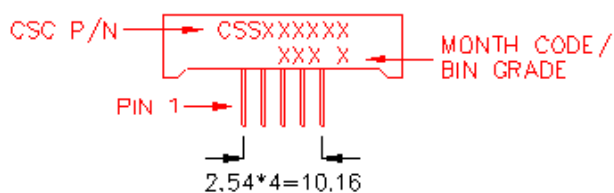
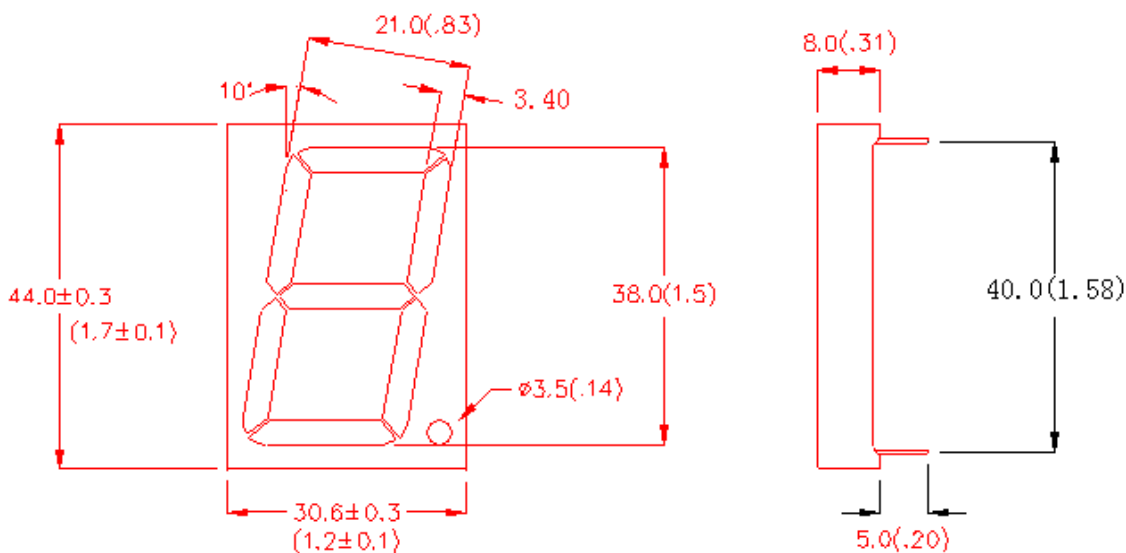

**NOTE:**

- 1 All Pins are  $\phi 0.5$  (.02).
- 2 Dimension in millimeter (inch), and tolerance is 0.25 (.01) unless otherwise noted.



**Model No: CSS-15102D-21**

**Internal Circuit Diagrams -**

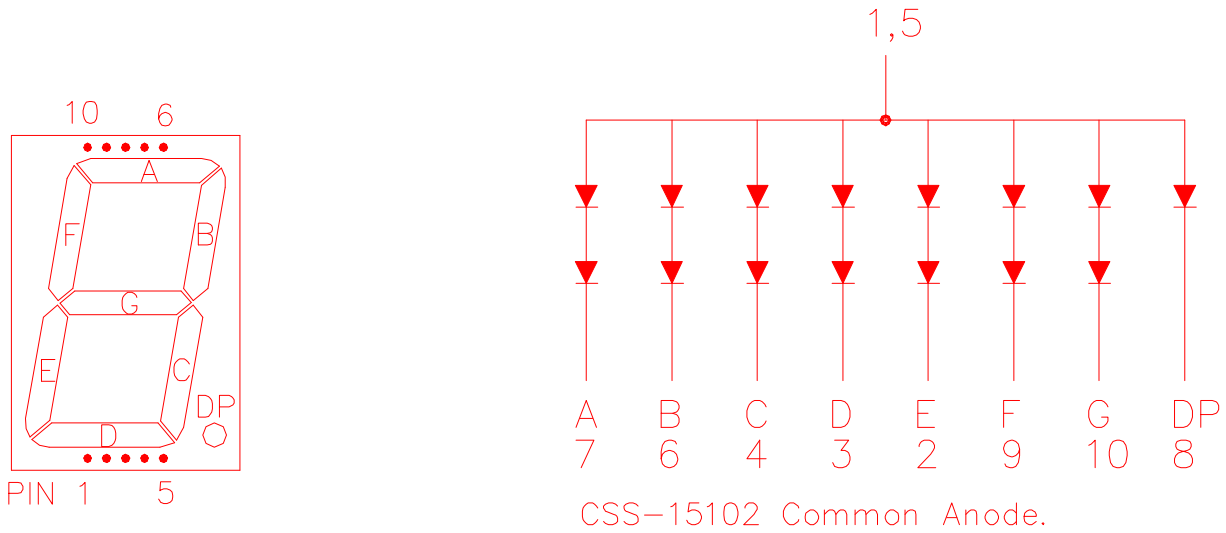

**Absolute Maximum Rating -**

(Ta=25°C)

Parameter	Symbol	Rating	Unit
Power Dissipation Per Dice	<b>Pd</b>	75	mW
Continuous Forward Current Per Dice	<b>IAF</b>	30	mA
Peak Current Per Dice	<b>IPF</b>	200	mA
Reverse Voltage Per Dice	<b>VR</b>	5	V
Operating Temp.	<b>Topr</b>	-25 ~ +85	°C
Storage Temp.	<b>Tstg</b>	-25 ~ +85	°C
Solder emperature 1/16 inch below seating plane for 3 seconds at 260°C			



Spec. No.	PS-ND-0711
Rev.	A

**Model No : CSS-15102D-21**

■ **Electro-optical Characteristics -**

(Ta=25°C)

Parameter	Symbol	Min.	Typ.	Max.	Unit	Condition
Forward Voltage Per Segment(DP)	$V_F$	-	3.6(1.8)	5.0(2.5)	V	I <sub>F</sub> =20mA
Luminous Intensity Per Segment	$I_V$	-	55	-	mcd	
Peak Emission Wavelength	$\lambda_P$	-	660	-	nm	
Spectrum Radiation Bandwidth	$\Delta \lambda$	-	20	-	nm	
Reverse Current	$I_R$	-	-	100	$\mu A$	V <sub>R</sub> =10V



**Model No: CSS-15102D-21**

**Typical Electrical / Optical Characteristics Curves -**

**(Ta = 25°C Unless Otherwise Noted)**

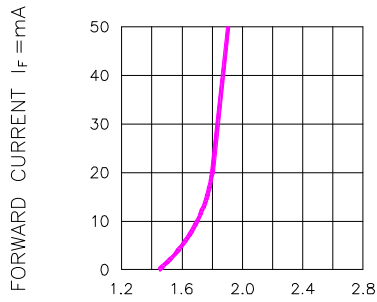

FORWARD VOLTAGE (V<sub>F</sub>)-VOLTS  
Fig.1 FORWARD CURRENT VS. FORWARD VOLTAGE

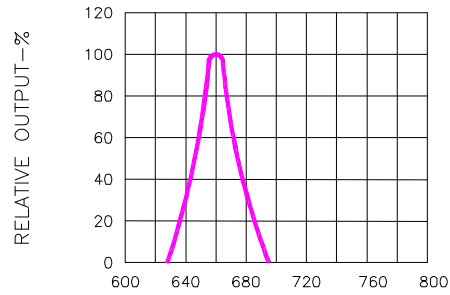

WAVELENGTH (λ)-nm  
Fig.2 SPECTRAL RESPONSE

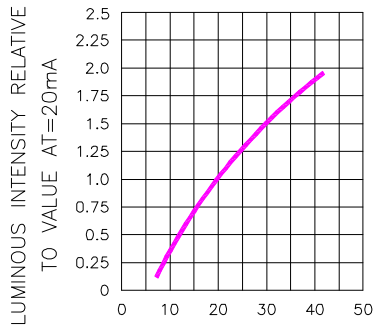

I<sub>F</sub>-FORWARD CURRENT-mA  
Fig.3 RELATIVE LUMINOUS INTENSITY VS. FORWARD CURRENT

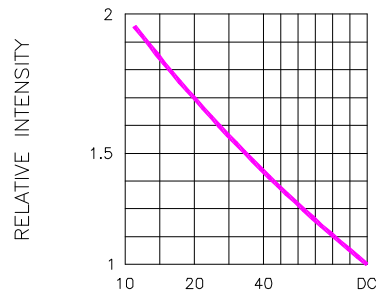

DUTY CYCLE % PER SEGMENT (AVERAGE I<sub>F</sub>=10mA)  
Fig.5 LUMINOUS INTENSITY VS. DUTY CYCLE

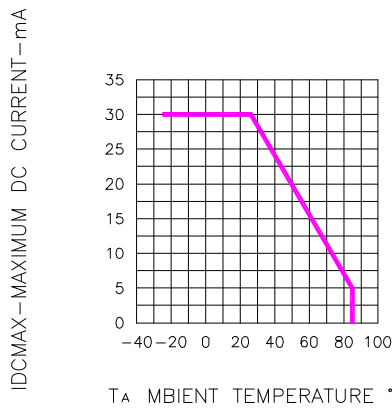

T<sub>A</sub> AMBIENT TEMPERATURE °C  
Fig.4 MAXIMUM ALLOWABLE DC CURRENT PER SEGMENT VS. A FUNCTION OF AMBIENT TEMPERATURE

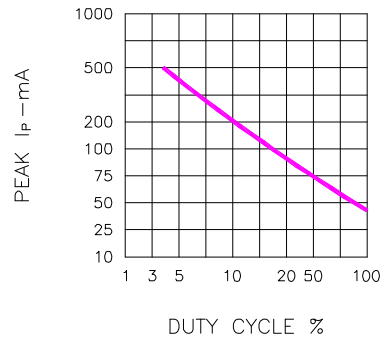

Fig.6 MAX PEAK CURRENT VS. DUTY CYCLE % (REFRESH RATE f=1 KHz)



Spec. No.	PS-ND-0711
Rev.	A

Model No: CSS-15102D-21

■ Package Dimensions

